

EXPERT 10.6 HV

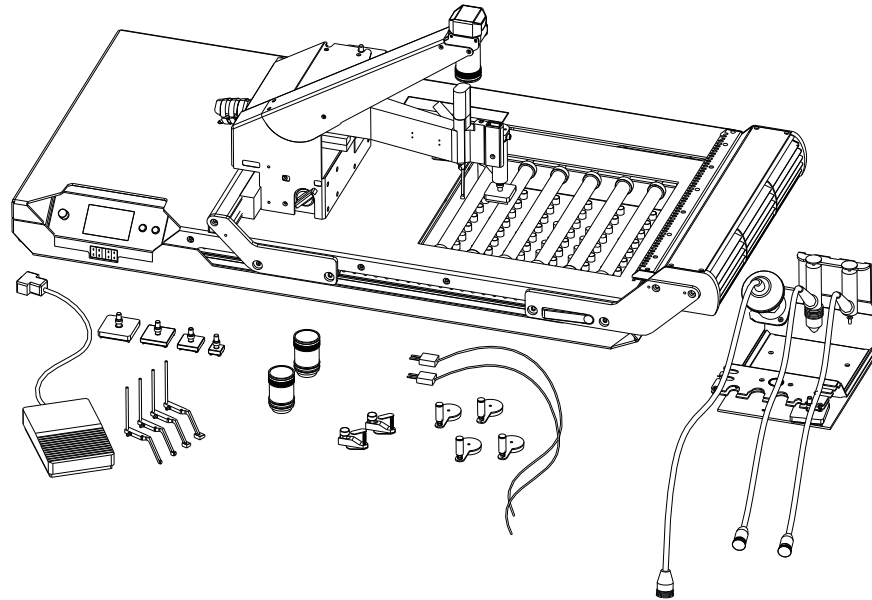

Rework Station with 3000W hybrid under heater. The heating area of 275x245mm² is adjustable to PCB size. Automated SMD placement process by Auto Vision Placer (AVP) incl. Easy Solder software package and DBL 06 control unit with six high resolution sensors inputs for thermocouples (Type K).

This system is particularly suitable for mid size and big PCBs with Fine Pitch components with varying package dimensions.

Standard Equipment (Art.No. DB00.1065)

- Tool set for dispensing, placing, residual solder removal and soldering with magazine
- Set of placement nozzles (BGA/CSP) 3mm, 5mm, 8mm, 10mm
- Set of solder nozzles (BGA) 15mm, 27mm, 35mm, 40mm
- Two camera lenses (BGA und CSP)
- Two thermo couple sensors (type K)
- Four PCB magnet holder 40,5mm (standard)
- Two PCB clips to install at hand rest
- Foot switch
- Rework ABC and manual







Technical Data

System power consumption:	3500 VA
Power solder pen :	300 W, 35 l/min
Power underheater:	600-3000 W, 6 x IR-lamps
Effective heating area:	275 x 245 mm ²
Recommended max. PCB size:	305 x 305 mm ²
Resolution motion system:	0,001 mm
Placement accuracy :	± 0,015 mm (Flip Chip)* ± 0,030 mm (CSP) ± 0,040 mm (BGA) ± 0,070 mm (Maxi BGA)*
High resolution CMOS-camera:	5 Mio. Pixel, USB2
Camera field of view (FOV):	14 x 18 mm ² (Flip Chip)* 28 x 37 mm ² (CSP) 37 x 50 mm ² (BGA) 65 x 85 mm ² (Maxi BGA)*
Mains:	1 Phase, 230VAC, 25A/Phase, Fuse 16A, Connector Type CEE 32A (3 phase)
Pressurized air:	5 - 8 bar, 100 l/min clean dry air
Foot print:	865 x 460 mm ²

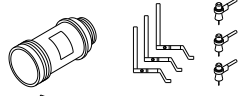
* Optional Extras

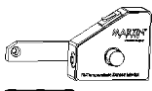
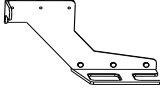
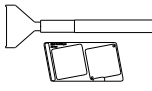
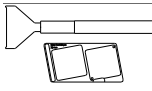
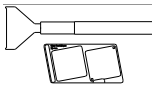
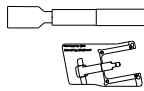
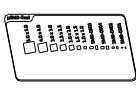
EXPERT 10.6 HV

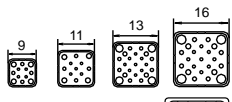
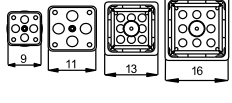
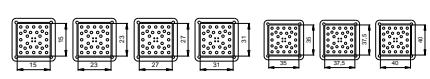
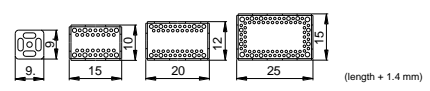
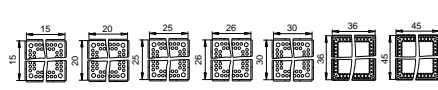
Optional Extras

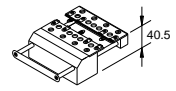
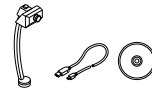
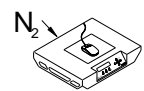
SF66.0004	Micro SMD nozzles and lens for AVP 4 licence MS, 3 n, 3 solder n, lens FC	
DVSX.0007	Report with pcb Identification for ES 05, licence RP	 Report
SF71.0003	IR temperatur sensor for AVP04.1	
SF64.0501	Tool slider for AVP 4.1	
SF64.0525	Dipp tool 32x0,08mm with squeegee for tool slider	
SF64.0526	Dipp tool 32x0,15mm with squeegee for tool slider	
SF64.0527	Dipp tool 32x0,22mm with squeegee for tool slider	
SF64.0520	Print tool with squeegee for tool slider	
SF64.0540	μSMD tool for tool slider	
SF66.0110	Lens Maxi BGA for AVP4/4XL, f=16mm, 65*85mm	 Maxi-BGA AVP4
LW40.1096	Soldering nozzle set CSP/QFN for all CSP types, 4 pieces (9, 11, 13, 16)	
LW40.1104	Soldering nozzle set CSP with vacuum for all CSP types, 4 pieces (9, 11, 13, 16)	
LW40.1099	Solder Nozzle Set BGA 7 for all (98%) types of BGA, 7 pieces	
LW01.0400	Soldering Tool Set SO (lead free) for all SO...SOL...TSOP, 4 pieces	 (length + 1.4 mm)
LW01.0100	Soldering Tool Set QFP for all PLCC ...QFP, 7 pieces	
SF36.1001	PCB flex support 40,5 for HIF 08 and IRF, "10 pin"	
SF03.0019	PCB Clamping Holder 40.5 with 3 fingers for mobile phone pbcs on HB-05/ IR/IRD/IRH/IRF/HIF	 40.5
SF71.0001	Side Camera for ES-05, camera, stand, cable, DVD	
DB00.0025	Nitrogen input for DBL 04/05/06 (2.p.r) reduces consumption of N2 for vacuum	 N ₂